

# **eZdsp<sup>TM</sup> F2812**

*Technical  
Reference*



eZdsp™ F2812  
Technical Reference

506265-0001 Rev. F  
September 2003

**SPECTRUM DIGITAL, INC.**  
12502 Exchange Dr., Suite 440 Stafford, TX. 77477  
Tel: 281.494.4505 Fax: 281.494.5310  
sales@spectrumdigital.com www.spectrumdigital.com

### **IMPORTANT NOTICE**

Spectrum Digital, Inc. reserves the right to make changes to its products or to discontinue any product or service without notice. Customers are advised to obtain the latest version of relevant information to verify data being relied on is current before placing orders.

Spectrum Digital, Inc. warrants performance of its products and related software to current specifications in accordance with Spectrum Digital's standard warranty. Testing and other quality control techniques are utilized to the extent deemed necessary to support this warranty.

Please be aware, products described herein are not intended for use in life-support appliances, devices, or systems. Spectrum Digital does not warrant, nor is it liable for, the product described herein to be used in other than a development environment.

Spectrum Digital, Inc. assumes no liability for applications assistance, customer product design, software performance, or infringement of patents or services described herein. Nor does Spectrum Digital warrant or represent any license, either express or implied, is granted under any patent right, copyright, or other intellectual property right of Spectrum Digital, Inc. covering or relating to any combination, machine, or process in which such Digital Signal Processing development products or services might be or are used.

### **WARNING**

This equipment is intended for use in a laboratory test environment only. It generates, uses, and can radiate radio frequency energy and has not been tested for compliance with the limits of computing devices pursuant to subpart J of part 15 of FCC rules, which are designed to provide reasonable protection against radio frequency interference. Operation of this equipment in other environments may cause interference with radio communications, in which case the user, at his own expense, will be required to take any measures necessary to correct this interference.

### **TRADEMARKS**

**eZdsp** is a trademark of Spectrum Digital, Inc.

# Contents

---

---

<b>1</b>	<b>Introduction to the eZdsp™ F2812</b> .....	<b>1-1</b>
	<i>Provides a description of the eZdsp™ F2812, key features, and board outline.</i>	
1.0	Overview of the eZdsp™ F2812 .....	1-2
1.1	Key Features of the eZdsp™ F2812 .....	1-2
1.2	Functional Overview of the eZdsp™ F2812 .....	1-3
<b>2</b>	<b>Operation of the eZdsp™ F2812</b> .....	<b>2-1</b>
	<i>Describes the operation of the eZdsp™ F2812. Information is provided on the DSK's various interfaces.</i>	
2.0	The eZdsp™ F2812 Operation .....	2-2
2.1	The eZdsp™ F2812 Board .....	2-2
2.1.1	Power Connector .....	2-3
2.2	eZdsp™ F2812 Memory .....	2-3
2.2.1	Memory Map .....	2-4
2.3	eZdsp™ F2812 Connectors .....	2-5
2.3.1	P1, JTAG Interface .....	2-6
2.3.2	P2, Expansion Interface .....	2-7
2.3.3	P3, Parallel Port/JTAG Interface .....	2-9
2.3.4	P4,P8,P7, I/O Interface .....	2-9
2.3.5	P5,P9, Analog Interface .....	2-11
2.3.6	P6, Power Connector .....	2-13
2.3.7	Connector Part Numbers .....	2-14
2.4	eZdsp™ F2812 Jumpers .....	2-14
2.4.1	JP1, XMP/MCn Select .....	2-15
2.4.2	JP4, JP5, Voltage Jumpers .....	2-16
2.4.2.1	JP4, +3.3/5 Volts for P8, P2 .....	2-17
2.4.2.2	JP5, +3.3/5 Volts for P4 .....	2-17
2.4.3	JP7,JP8,JP11,JP12, Boot Mode Select .....	2-18
2.4.4	JP9, PLL Select .....	2-18
2.5	LEDS .....	2-19
2.6	Test Points .....	2-19
<b>A</b>	<b>eZdsp™ F2812 Schematics</b> .....	<b>A-1</b>
	<i>Contains the schematics for the socketed and unsocketed versions of the eZdsp™ F2812</i>	
<b>B</b>	<b>eZdsp™ F2812 Mechanical Information</b> .....	<b>B-1</b>
	<i>Contains the mechanical information about the socketed and unsocketed versions of the eZdsp™ F2812</i>	

## List of Figures

Figure 1-1, Block Diagram eZdsp™ F2812	1-3
Figure 2-1, eZdsp™ F2812 PCB Outline	2-2
Figure 2-2, eZdsp™ F2812 Memory Space	2-4
Figure 2-3, eZdsp™ F2812 Connector Positions	2-5
Figure 2-4, Connector P1 Pin Locations	2-6
Figure 2-5, Connector P2 Pin Locations	2-7
Figure 2-6, Connector P4/P8/P7 Connectors	2-9
Figure 2-7, Connector P5/P9 Pin Locations	2-11
Figure 2-8, Connector P6 Location	2-13
Figure 2-9, eZdsp™ F2812 Power Connector	2-13
Figure 2-10, eZdsp™ F2812 Jumper Positions	2-15
Figure 2-11, eZdsp™ F2812 Voltage Jumper Positions(Bottom side)	2-16

## List of Tables

Table 2-1, External Chip Select and Usages	2-3
Table 2-2, eZdsp™ F2812 Connectors	2-5
Table 2-3, P1, JTAG Interface Connector	2-6
Table 2-4, P2, Expansion Interface Connector	2-8
Table 2-5, P4/P8, I/O Connectors	2-10
Table 2-6, P7, I/O Connector	2-11
Table 2-7, P5/P9, Analog Interface Connector	2-12
Table 2-8, Connector Part Numbers	2-14
Table 2-9, eZdsp™ F2812 Jumpers	2-14
Table 2-10, JP1, XMP/MCn Select	2-15
Table 2-11, JP4, +3.3/5 Volts for P8, P2	2-17
Table 2-12, JP5, +3.3/ Volts for P4	2-17
Table 2-13, JP7,JP8, JP11, JP12, Boot Mode Select	2-18
Table 2-14, JP9, PLL Disable	2-18
Table 2-15, LEDs	2-19
Table 2-16, Test Points	2-19

## About This Manual

This document describes board level operations of the eZdsp™ F2812 based on the Texas Instruments TMS320F2812 Digital Signal Processor.

The eZdsp™ F2812 is a stand-alone module permitting engineers and software developers evaluation of certain characteristics of the TMS320F2812 DSP to determine processor applicability to design requirements. Evaluators can create software to execute onboard or expand the system in a variety of ways.

## Notational Conventions

This document uses the following conventions.

The “eZdsp™ F2812” will sometimes be referred to as the “eZdsp”.

“eZdsp” will include the socketed or unsocket version

Program listings, program examples, and interactive displays are shown in a special italic typeface. Here is a sample program listing.

```
equations  
!rd = !strobe&rw;
```

## Information About Cautions

This book may contain cautions.

***This is an example of a caution statement.***

A caution statement describes a situation that could potentially damage your software, hardware, or other equipment. The information in a caution is provided for your protection. Please read each caution carefully.

## Related Documents

Texas Instruments TMS320C28x DSP CPU and Instruction Set Reference Guide,  
literature #SPRU430  
Texas Instruments TMS320C28x Assembly Language Tools Users Guide,  
literature #SPRU513  
Texas Instruments TMS320C28x Optimizing C/C++ Compiler User's Guide,  
literature #SPRU514  
Texas Instruments Code Composer Studio Getting Started Guide,  
literature #SPRU509





# Chapter 1

## Introduction to the eZdsp™ F2812

---

---

This chapter provides a description of the eZdsp™ for the TMS320F2812 Digital Signal Processor, key features, and block diagram of the circuit board.

Topic	Page
1.0 Overview of the eZdsp™ F2812	1-2
1.1 Key Features of the eZdsp™ F2812	1-2
1.2 Functional Overview of the eZdsp™ F2812	1-3

## **1.0 Overview of the eZdsp™ F2812**

The eZdsp™ F2812 is a stand-alone card--allowing evaluators to examine the TMS320F2812 digital signal processor (DSP) to determine if it meets their application requirements. Furthermore, the module is an excellent platform to develop and run software for the TMS320F2812 processor.

The eZdsp™ F2812 is shipped with a TMS320F2812 DSP. The eZdsp™ F2812 allows full speed verification of F2812 code. Two expansion connectors are provided for any necessary evaluation circuitry not provided on the as shipped configuration.

To simplify code development and shorten debugging time, a C2000 Tools Code Composer driver is provided. In addition, an onboard JTAG connector provides interface to emulators, operating with other debuggers to provide assembly language and 'C' high level language debug.

### **1.1 Key Features of the eZdsp™ F2812**

The eZdsp™ F2812 has the following features:

- TMS320F2812 Digital Signal Processor
- 150 MIPS operating speed
- 18K words on-chip RAM
- 128K words on-chip Flash memory
- 64K words off-chip SRAM memory
- 30 MHz. clock
- 2 Expansion Connectors (analog, I/O)
- Onboard IEEE 1149.1 JTAG Controller
- 5-volt only operation with supplied AC adapter
- TI F28xx Code Composer Studio tools driver
- On board IEEE 1149.1 JTAG emulation connector

## 1.2 Functional Overview of the eZdsp™ F2812

Figure 1-1 shows a block diagram of the basic configuration for the eZdsp™ F2812. The major interfaces of the eZdsp are the JTAG interface, and expansion interface.

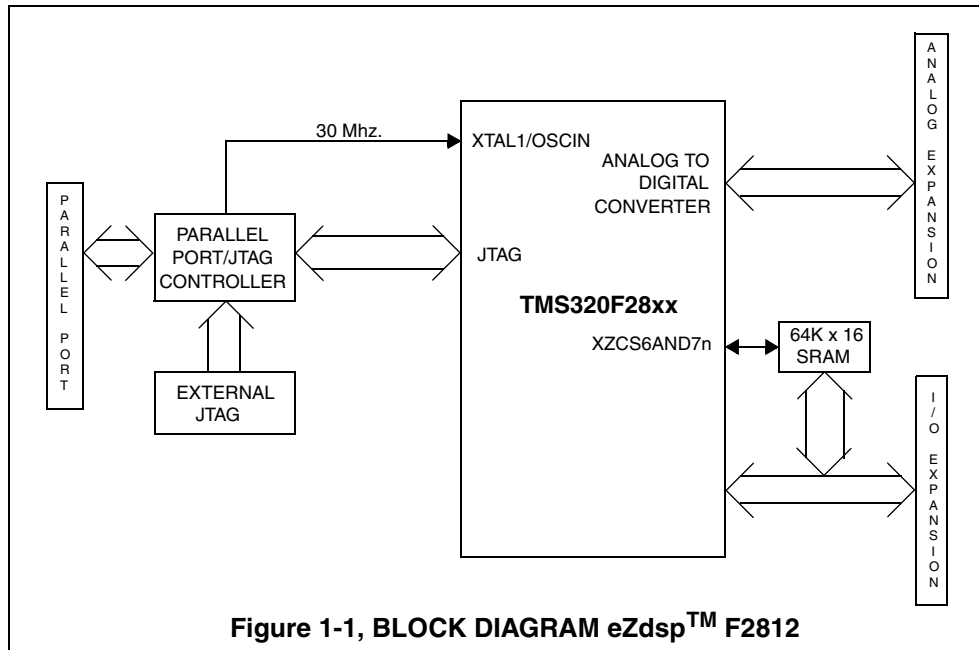



## Chapter 2

# Operation of the eZdsp™ F2812

---

---

This chapter describes the operation of the eZdsp™ F2812, key interfaces and includes a circuit board outline.

Topic	Page
2.0 The eZdsp™ F2812 Operation	2-2
2.1 The eZdsp™ F2812 Board	2-2
2.1.1 Power Connector	2-3
2.2 eZdsp™ F2812 Memory	2-3
2.2.1 Memory Map	2-4
2.3 eZdsp™ F2812 Connectors	2-5
2.3.1 P1, JTAG Interface	2-6
2.3.2 P2, Expansion Interface	2-7
2.3.3 P3, Parallel Port/JTAG Interface	2-9
2.3.4 P4,P8,P7, I/O Interface	2-9
2.3.5 P5,P9, Analog Interface	2-11
2.3.6 P6, Power Connector	2-13
2.3.7 Connector Part Numbers	2-14
2.4 eZdsp™ F2812 Jumpers	2-14
2.4.1 JP1, XMP/MCn Select	2-15
2.4.2 JP4, JP5 Voltage Jumpers	2-16
2.4.2.1 JP4, +3.3/5 Volts for P8, P4	2-17
2.4.2.2 JP5, +3.3/5 Volts for P2	2-17
2.4.3 JP7,JP8,JP11,JP12, Boot Mode Select	2-18
2.4.4 JP9, PLL Disable	2-18
2.5 LEDs	2-19
2.6 Test Points	2-19

## 2.0 The eZdsp™ F2812 Operation

This chapter describes the eZdsp™ F2812, key components, and operation. Information on the eZdsp's various interfaces is also included. The eZdsp™ F2812 consists of four major blocks of logic:

- Analog Interface Connector
- I/O Interface Connector
- JTAG Interface
- Parallel Port JTAG Controller Interface

## 2.1 The eZdsp™ F2812 Board

The eZdsp™ F2812 is a 5.25 x 3.0 inch, multi-layered printed circuit board, powered by an external 5-Volt only power supply. Figure 2-1 shows the layout of both the socketed and unsocketed version of the F2812 eZdsp.

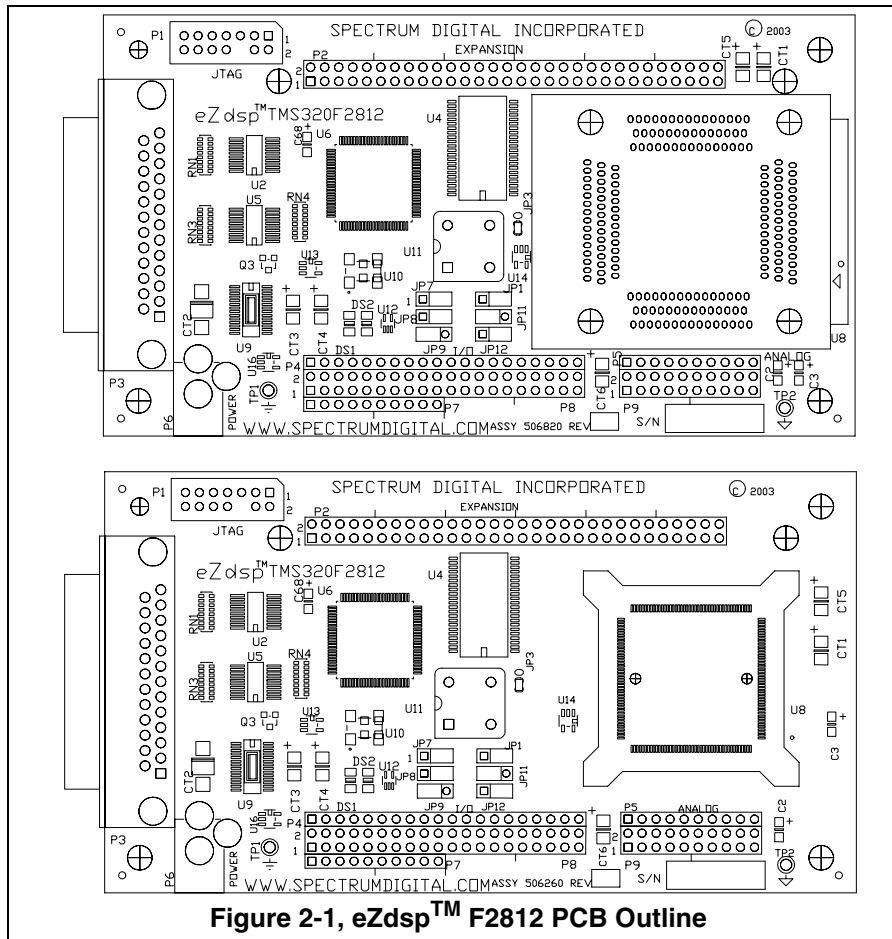

Figure 2-1, eZdsp™ F2812 PCB Outline

### 2.1.1 Power Connector

The eZdsp™ F2812 is powered by a 5-Volt only power supply, included with the unit. The unit requires 500mA. The power is supplied via connector P6. If expansion boards are connected to the eZdsp, a higher amperage power supply may be necessary. Section 2.3.6 provides more information on connector P6.

### 2.2 eZdsp™ F2812 Memory

The eZdsp includes the following on-chip memory:

- 128K x 16 Flash
- 2 blocks of 4K x 16 single access RAM (SARAM)
- 1 block of 8K x 16 SARAM
- 2 blocks of 1K x 16 SARAM

In addition 64K x 16 off-chip SRAM is provided. The processor on the eZdsp can be configured for boot-loader mode or non-boot-loader mode.

The eZdsp can load ram for debug or FLASH ROM can be loaded and run. For larger software projects it is suggested to do a initial debug with on eZdsp F2812 module which supports a total RAM environment. With careful attention to the I/O mapping in the software the application code can easily be ported to the F2812.

The table below shows the external chip select signal and its use.

**Table 1: External Chip Select and Usage**

Chip Select Signal	Use
XZCS0AND1n	Expansion header
XZCS2n	Expansion Header
XZCS6AND7n	External SRAM

### 2.2.1 Memory Map

The figure below shows the memory map configuration on the eZdsp™ F2812.

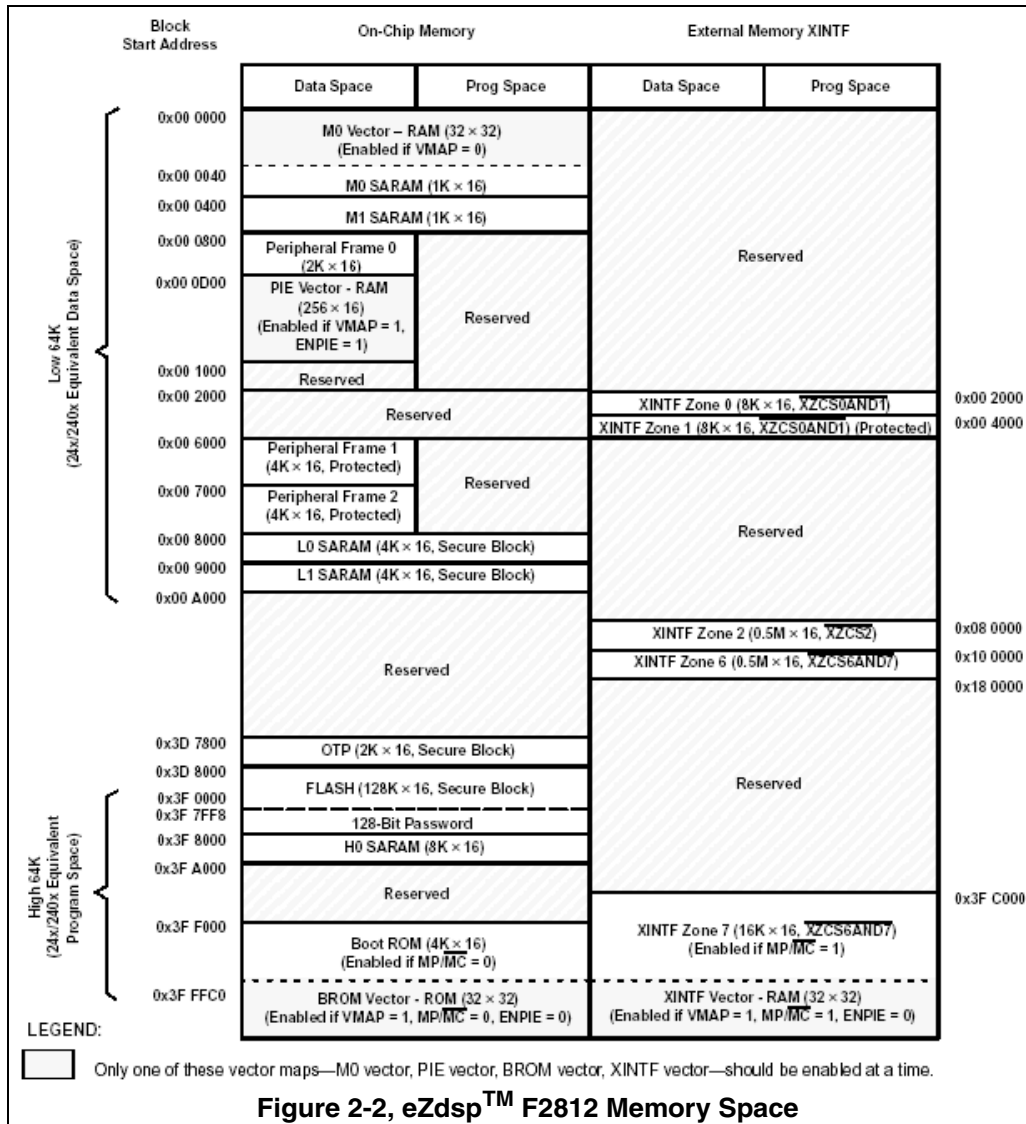

**Note:** The on-chip flash memory has a security key which can prevent visibility when enabled.



### 2.3 eZdsp™ F2812 Connectors

The eZdsp™ F2812 has five connectors. Pin 1 of each connector is identified by a square solder pad. The function of each connector is shown in the table below:

**Table 2: eZdsp™ F2812 Connectors**

Connector	Function
P1	JTAG Interface
P2	Expansion
P3	Parallel Port/JTAG Controller Interface
P4/P8/P7	I/O Interface
P5/P9	Analog Interface
P6	Power Connector

The diagram below shows the position of each connector

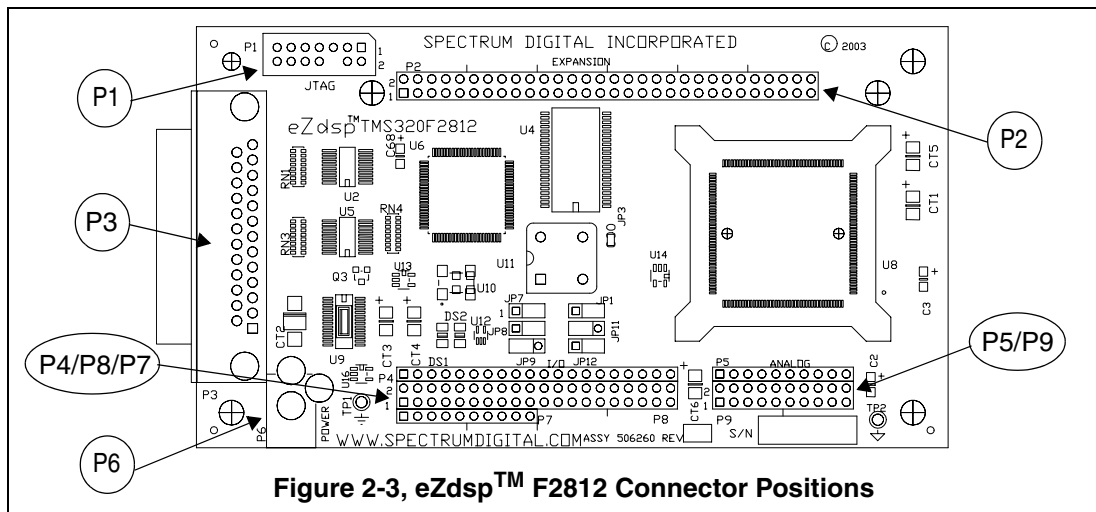

### 2.3.1 P1, JTAG Interface

The eZdsp™ F2812 is supplied with a 14-pin header interface, P1. This is the standard interface used by JTAG emulators to interface to Texas Instruments DSPs.

The positions of the 14 pins on the P1 connector are shown in the diagram below as viewed from the top of the eZdsp.

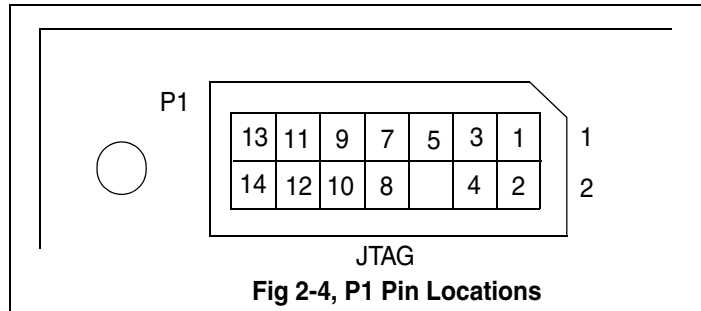

The definition of P1, which has the JTAG signals is shown below.

**Table 3: P1, JTAG Interface Connector**

Pin #	Signal	Pin #	Signal
1	TMS	2	TRST-
3	TDI	4	GND
5	PD (+5V)	6	<b>no pin</b>
7	TDO	8	GND
9	TCK-RET	10	GND
11	TCK	12	GND
13	EMU0	14	EMU1

**WARNING !**

The TMS320F2812 supports +3.3V Input/Output levels which are NOT +5V tolerant. Connecting the eZdsp to a system with +5V Input/Output levels will damage the TMS320F2812. If the eZdsp is connected to another target then the eZdsp must be powered up first and powered down last to prevent latchup conditions.

**2.3.2 P2, Expansion Interface**

The positions of the 60 pins on the P2 connector are shown in the diagram below as viewed from the top of the eZdsp.

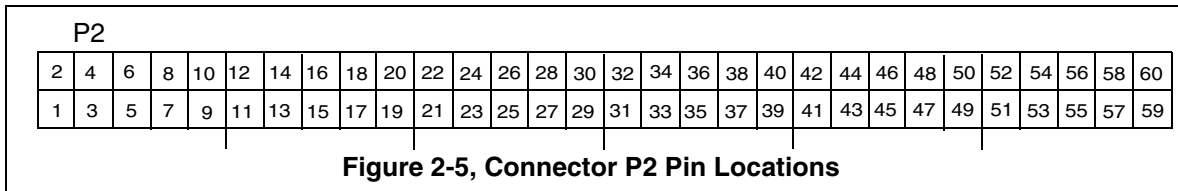

The definition of P2, which has the I/O signal interface is shown below.

**Table 4: P2, Expansion Interface Connector**

Pin #	Signal	Pin #	Signal
1	+3.3V/+5V/NC *	2	+3.3/+5V/NC *
3	XD0	4	XD1
5	XD2	6	XD3
7	XD4	8	XD5
9	XD6	10	XD7
11	XD8	12	XD9
13	XD10	14	XD11
15	XD12	16	XD13
17	XD14	18	XD15
19	XA0	20	XA1
21	XA2	22	XA3
23	XA4	24	XA5
25	XA6	26	XA7
27	XA8	28	XA9
29	XA10	30	XA11
31	XA12	32	XA13
33	XA14	34	XA15
35	GND	36	GND
37	XZCS0AND1n	38	XZCS2n
39	XREADY	40	10K Pull-up
41	XRnW	42	10K Pull-up
43	XWE	44	XRDn
45	+3.3V	46	XNMI/INT13
47	XRSn/RSn	48	No connect
49	GND	50	GND
51	GND	52	GND
53	XA16	54	XA17
55	XA18	56	XHOLDn
57	XHOLDAn	58	No connect
59	No connect	60	No connect

\* Default is No Connect (NC). User can jumper to +3.3V or +5V on backside of eZdsp with JP5.

### 2.3.3 P3, Parallel Port/JTAG Interface

The eZdsp™ F2812 uses a custom parallel port-JTAG interface device. This device incorporates a standard parallel port interface that supports ECP, EPP, and SPP8/bidirectional communications. The device has direct access to the integrated JTAG interface. Drivers for C2000 Code Composer tools are shipped with the eZdsp modules

### 2.3.4 P4/P8/P7, I/O Interface

The connectors P4, P8, and P7 present the I/O signals from the DSP. The layout of these connectors are shown below.

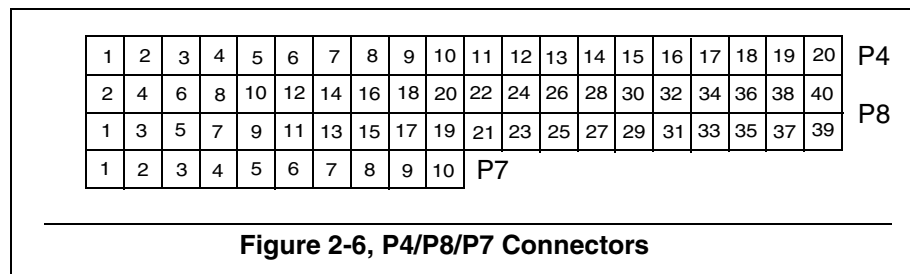

The pin definition of P4/P8 connectors are shown in the table below.

**Table 5: P4/P8, I/O Connectors**

P4 Pin #	P4 Signal	P8 Pin #	P8 Signal	P8 Pin #	P8 Signal
1	+3.3V/+5V/NC *	1	+3.3V/+5V/NC *	2	+3.3V/+5V/NC *
2	XINT2/ADC SOC	3	SCITXDA	4	SCIRXDA
3	MCLKXA	5	XINT1n/XBIO <sub>n</sub>	6	CAP1/QEP1
4	MCLKRA	7	CAP2/QEP2	8	CAP3/QEP11
5	MFSXA	9	PWM1	10	PWM2
6	MFSRA	11	PWM3	12	PWM4
7	MDXA	13	PWM5	14	PWM6
8	MDRA	15	T1PWM/T1CMP	16	T2PWM/T2CMP
9	No connect	17	TDIRA	18	TCLKINA
10	GND	19	GND	20	GND
11	CAP5/QEP4	21	No connect	22	XINT1N/XBIO <sub>n</sub>
12	CAP6/QEP12	23	SPISIMOA	24	SPISOMIA
13	T3PWM/T3CMP	25	SPICLKA	26	SPISTEA
14	T4PWM/T4CMP	27	CANTXA	28	CANRXA
15	TDIRB	29	XCLKOUT	30	PWM7
16	TCLKINB	31	PWM8	32	PWM9
17	XF/XPLLDIS <sub>n</sub>	33	PWM10	34	PWM11
18	SCITXDB	35	PWM12	36	CAP4/QEP3
19	SCIRXDB	37	T1CTRIIP/PDPINTA <sub>n</sub>	38	T3CTRIIP/PDPINTB <sub>n</sub>
20	GND	39	GND	40	GND

\* Default is No Connect (NC). User can jumper to +3.3V or +5V on backside of eZdsp with JP4.

The pin definition of P7 connector is shown in the table below.

**Table 6: P7, I/O Connector**

P7 Pin #	P7 Signal
1	C1TRIPn
2	C2TRIPn
3	C3TRIPn
4	T2CTRIPn/EVASOCn
5	C4TRIPn
6	C5TRIPn
7	C6TRIPn
8	T4CTRIPn/EVBSOCn
9	No connect
10	GND

### 2.3.5 P5/P9, Analog Interface

The position of the 30 pins on the P5/P9 connectors are shown in the diagram below as viewed from the top of the eZdsp.

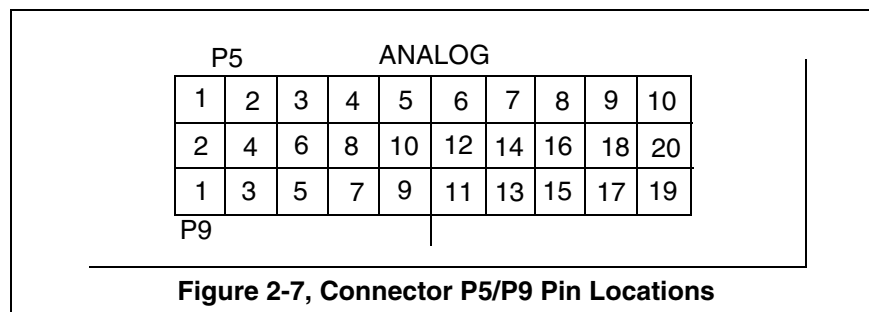

The definition of P5/P9 signals are shown in the table below.

**Table 7: P5/P9, Analog Interface Connector**

P5 Pin #	Signal	P9 Pin #	Signal	P9 Pin #	Signal
1	ADCINB0	1	GND	2	ADCINA0
2	ADCINB1	3	GND	4	ADCINA1
3	ADCINB2	5	GND	6	ADCINA2
4	ADCINB3	7	GND	8	ADCINA3
5	ADCINB4	9	GND	10	ADCINA4
6	ADCINB5	11	GND	12	ADCINA5
7	ADCINB6	13	GND	14	ADCINA6
8	ADCINB7	15	GND	16	ADCINA7
9	ADCREFM	17	GND	18	VREFLO *
10	ADCREFP	19	GND	20	No connect

\* Connect VREFLO to AGND or VREFLO of target system for proper ADC operation.



### 2.3.6 P6, Power Connector

Power (5 volts) is brought onto the eZdsp™ F2812 via the P6 connector. The connector has an outside diameter of 5.5 mm. and an inside diameter of 2 mm. The position of the P6 connector is shown below.

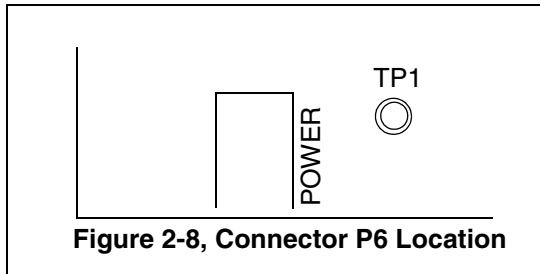

The diagram of P6, which has the input power is shown below.

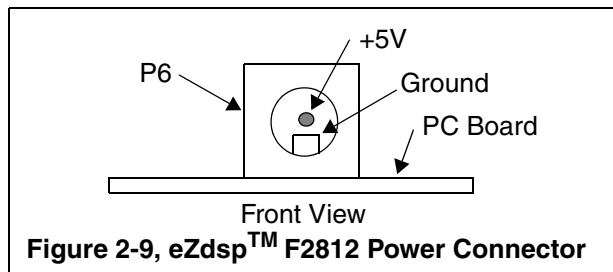

**2.3.7 Connector Part Numbers**

The table below shows the part numbers for connectors which can be used on the eZdsp™ F2812. Part numbers from other manufacturers may also be used.

**Table 8: eZdsp™ F2812 Suggested Connector Part Numbers**

Connector	Male Part Numbers	Female Part Numbers
P1	SAMTEC TSW-1-10-07-G-T	SAMTEC SSW-1-10-01-G-T
P2	SAMTEC TSW-1-20-07-G-T	SAMTEC SSW-1-20-01-G-T

\*SSW or SSQ Series can be used

**2.4 eZdsp™ F2812 Jumpers**

The eZdsp™ F2812 has 8 jumpers available to the user which determine how features on the eZdsp™ F2812 are utilized. The table below lists the jumpers and their function. The following sections describe the use of each jumper.

**Table 9: eZdsp™ F2812 Jumpers**

Jumper #	Size	Function	Position As Shipped From Factory
JP1	1 x 3	XMP/MCn	2-3
JP4	1 x 3	+3.3/5 Volts to P8,P4	Not connected
JP5	1 x 3	+3.3/5 Volts to P2	Not Connected
JP7	1 x 2	Boot Mode 3	2-3
JP8	1 x 3	Boot Mode 2	2-3
JP9	1 x 3	PLL Disable	1-2
JP11	1 x 3	Boot Mode 1	1-2
JP12	1 x 3	Boot Mode 0	2-3

**WARNING!**  
 Unless noted otherwise, all 1x3 jumpers must be installed in either the 1-2 or 2-3 position

The diagram below shows the positions of six jumpers on the component side of the eZdsp™ F2812.

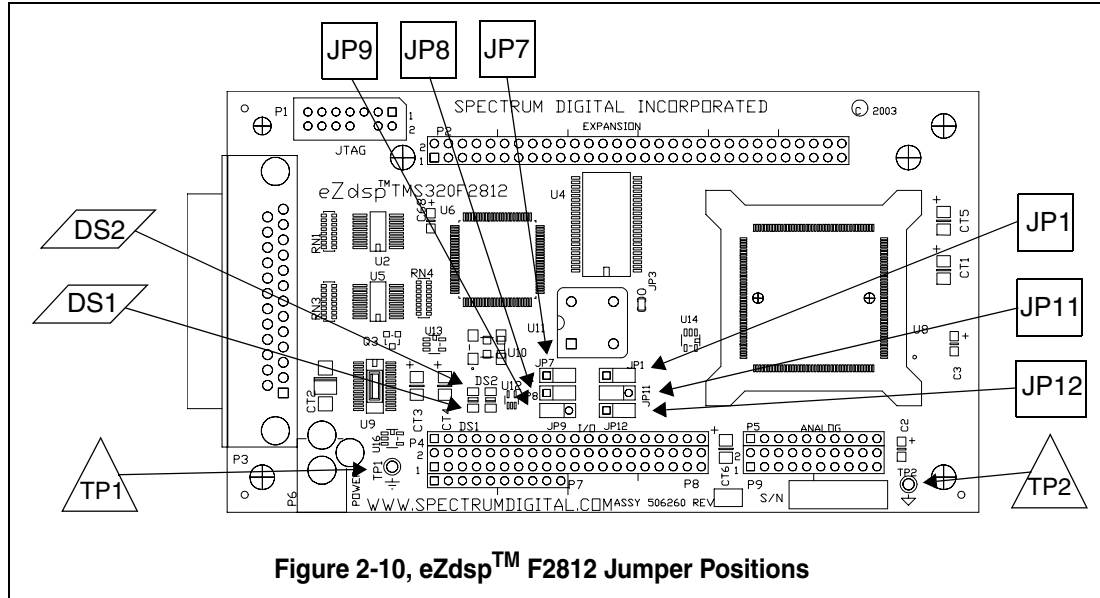

Figure 2-10, eZdsp™ F2812 Jumper Positions

#### 2.4.1 JP1, XMP/MCn Select

Jumper JP1 is used to select the XMP/MCn option. The 1-2 selection allows the DSP to operate in the Microcontroller mode. The 2-3 selection allow the DSP to operate in the Microprocessor mode. The positions are shown in the table below.

Table 10: JP1, XMP/MCn Select

Position	Function
1-2	Microprocessor mode
2-3 *	Microcomputer mode

\* as shipped from factory

### 2.4.2 JP4, JP5 Voltage Jumpers

Jumpers JP4 and JP5 are unpopulated jumpers on the bottom side of the board that provide either +3.3 volts or +5 volts to pins on the expansion connectors. These jumpers are shipped uninstalled to prevent accidental damage by connecting wires or circuitry to the expansion connector. The user may connect these jumpers by installing a jumper wire or zero ohm resistor. The position of these jumpers are shown in the figure below.

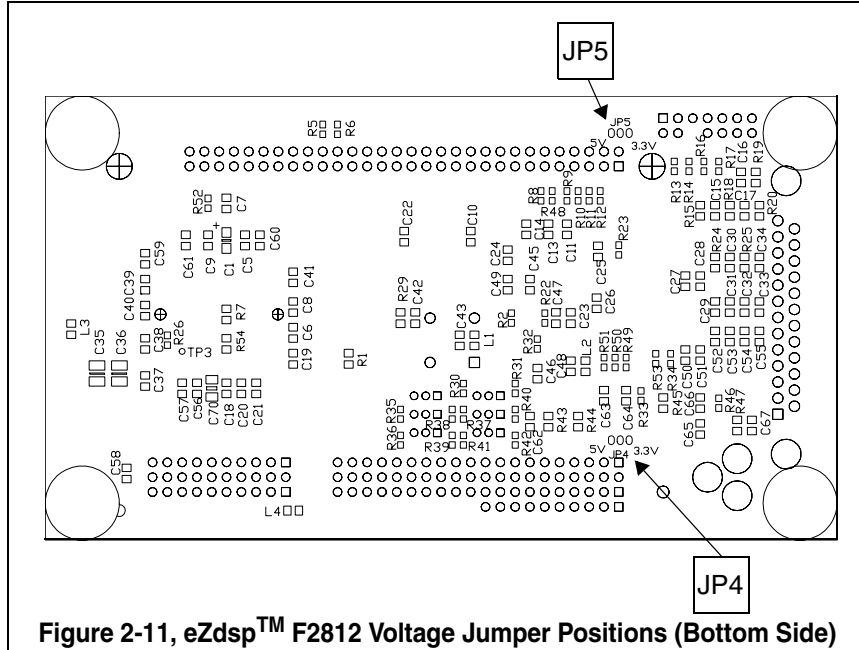





Figure 2-11, eZdsp™ F2812 Voltage Jumper Positions (Bottom Side)

**2.4.2.1 JP4, +3.3/5 Volts for P8, P4**

Jumper JP4 allows the user to provide either +3.3 or +5 volts to pins 1 and 2 of expansion connector P8, and pin 1 of P4. The settings for this jumper are shown in the table below

**Table 11: JP4, +3.3/5 Volts for P8, P4**





Position	Function	Jumper Position
1-2	Connect +5 Volts to P8, pins 1,2, and P4 pin1	5V  3.3V JP4
2-3	Connect +3.3 Volts to P8, pins 1,2, and P4 pin1	5V  3.3V JP4
No connect *		5V   3.3V JP4

\* As shipped from factory

**2.4.2.2 JP5, +3.3/5 Volts for P2**

Jumper JP5 allows the user to provide either +3.3 or +5 volts to pins 1 and 2 of expansion connector P2. The settings for this jumper are shown in the table below.

**Table 12: JP5, +3.3/5 Volts for P2**

Position	Function	Jumper Position
1-2	Connect +5 Volts to P2, pins 1,2	JP5 5V  3.3V
2-3	Connect +3.3 Volts to P2, pins 1,2	JP5 5V  3.3V
No connect *		JP5 5V   3.3V

\* As shipped from factory

**2.4.3 JP7, JP8, JP11, JP12, Boot Mode Select**

Jumpers JP7, JP8, JP11, JP12 are used to determine what mode the DSP will use for bootloading on power up. To set a signal high, place the jumper in the 1-2 position. For a low signal, use the 2-3 position. The options are shown in the table below.

**Table 13: JP7, JP8, JP11, JP12, Boot Mode Select**

JP7, BOOT3 SCITXDA	JP8, BOOT2 MDXA	JP11, BOOT1 SPISTEA	JP12, BOOT0 SPICLKA	MODE
1	X	X	X	FLASH
0	1	X	X	SPI
0	0	1	1	SCI
0	0	1	0	H0 *
0	0	0	1	OTP
0	0	0	0	PARALLEL

\* factory default

**2.4.4 JP9, PLL Disable**

Jumper JP9 is used to enable/disable the use of the Phase Lock Loop (PLL) logic on the DSP. The selection of the 1-2 position enables the use of the PLL. If the 2-3 position is used the PLL is disabled. This signal is latched at reset and may be used as XF after reset. The positions are shown in the table below.

**Table 14: JP9, PLL Disable**

Position	Function
1-2 *	PLL Enabled
2-3	PLL disabled

\* as shipped from the factory

## 2.5 LEDs

The eZdsp™ F2812 has two light-emitting diodes. DS1 indicates the presence of +5 volts and is normally 'on' when power is applied to the board. DS2 is under software control and is tied to the XF pin on the DSP through a buffer. These are shown in the table below.

**Table 15: LEDs**

LED #	Color	Controlling Signal
DS1	Green	+5 Volts
DS2	Green	XF bit (XF high = on)

## 2.6 Test Points

The eZdsp™ F2812 has two test points. The signals they are tied to are shown in the table below.

**Table 16: Test Points**

Test Point	Signal
TP1	Ground
TP2	Analog Ground





# Appendix A

## eZdsp™ F2812

### Schematics

---

---

---

The schematics for the eZdsp™ F2812 can be found on the CD-ROM that accompanies this board. The schematics were drawn on ORCAD.

The schematics are correct for both the socketed and unsocketed version of the eZdsp™.

#### **WARNING !**

The TMS320F2812 supports +3.3V Input/Output levels which are NOT +5V tolerant. Connecting the eZdsp to a system with +5V Input/Output levels will damage the TMS320F2812. If the eZdsp is connected to another target then the eZdsp must be powered up first and powered down last to prevent latchup conditions.

#### **Design Notes:**

1. The TMS320F2812 X1/CLKIN pin is +1.8 volt input. The clock input is buffered with a SN74LVC1G14 whose supply is +1.8 volts. This provides +3.3 volts to the +1.8 volt clock translation. Refer to sheet 4 of the schematics.



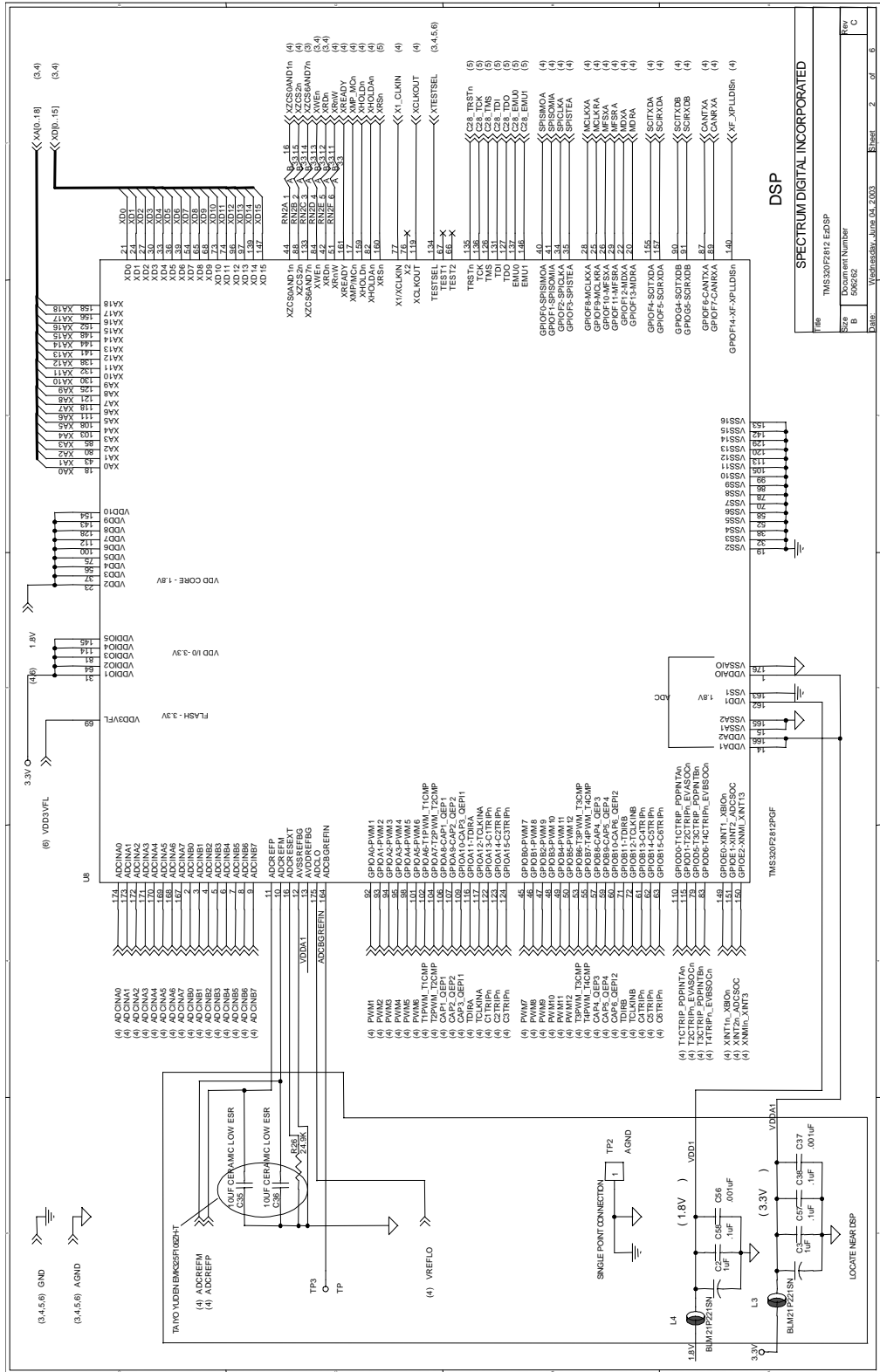

**DSP**

**SPECTRUM DIGITAL INCORPORATED**

File: TMS320F2812 EADSP  
 Size: Document Number  
 B: 506262  
 Date: Wednesday, June 04, 2003  
 Sheet: 2 of 6

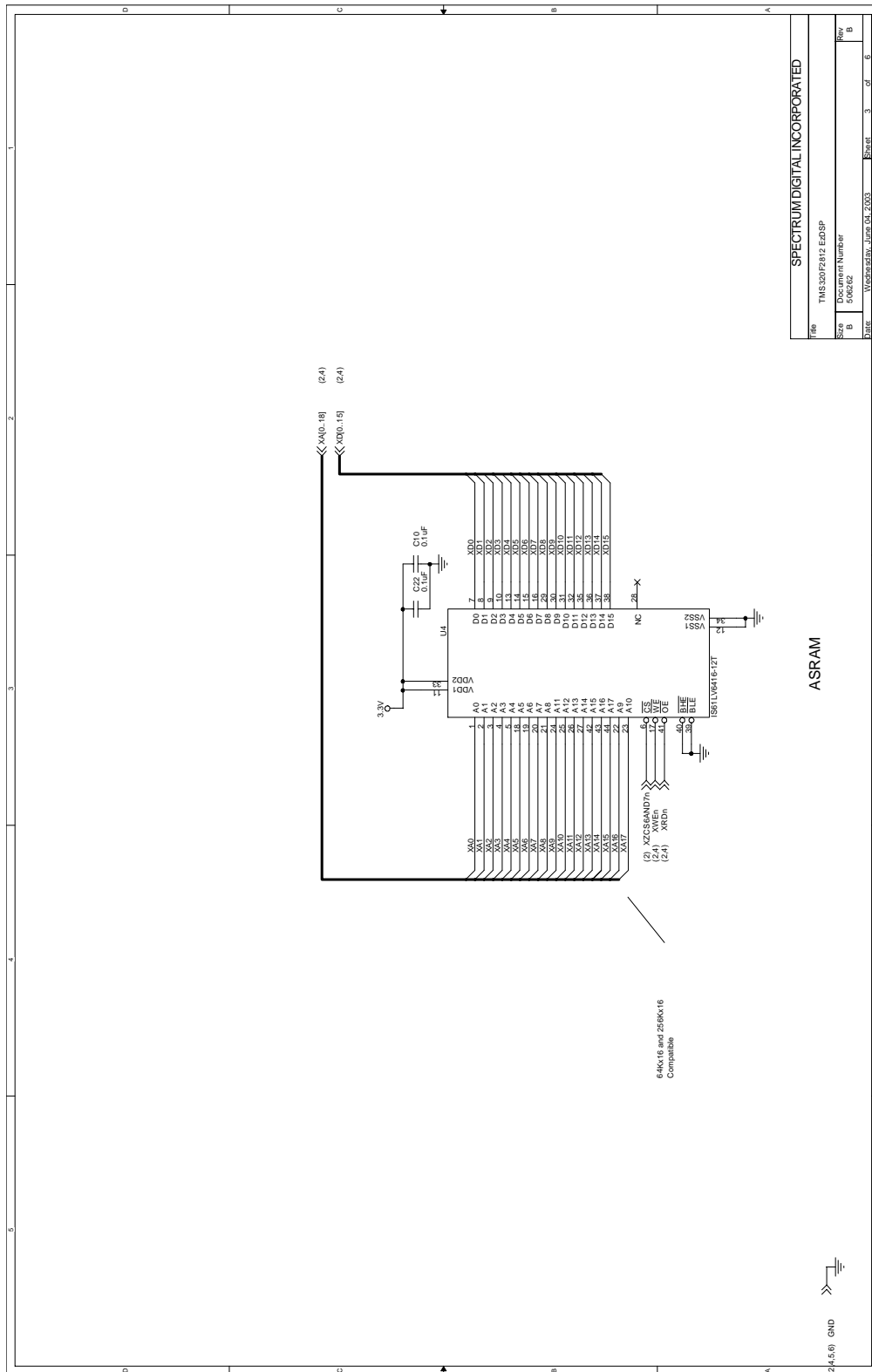

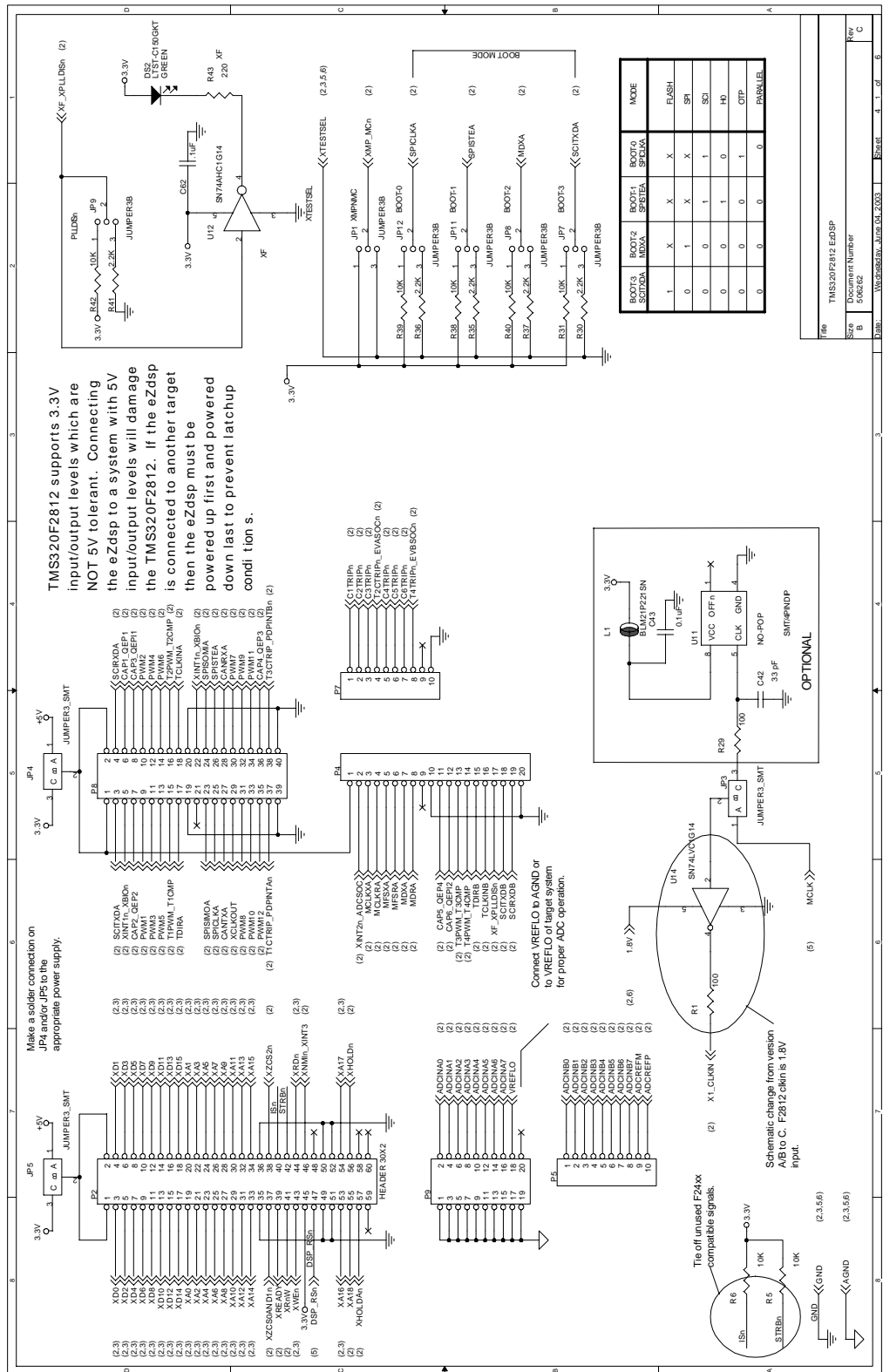



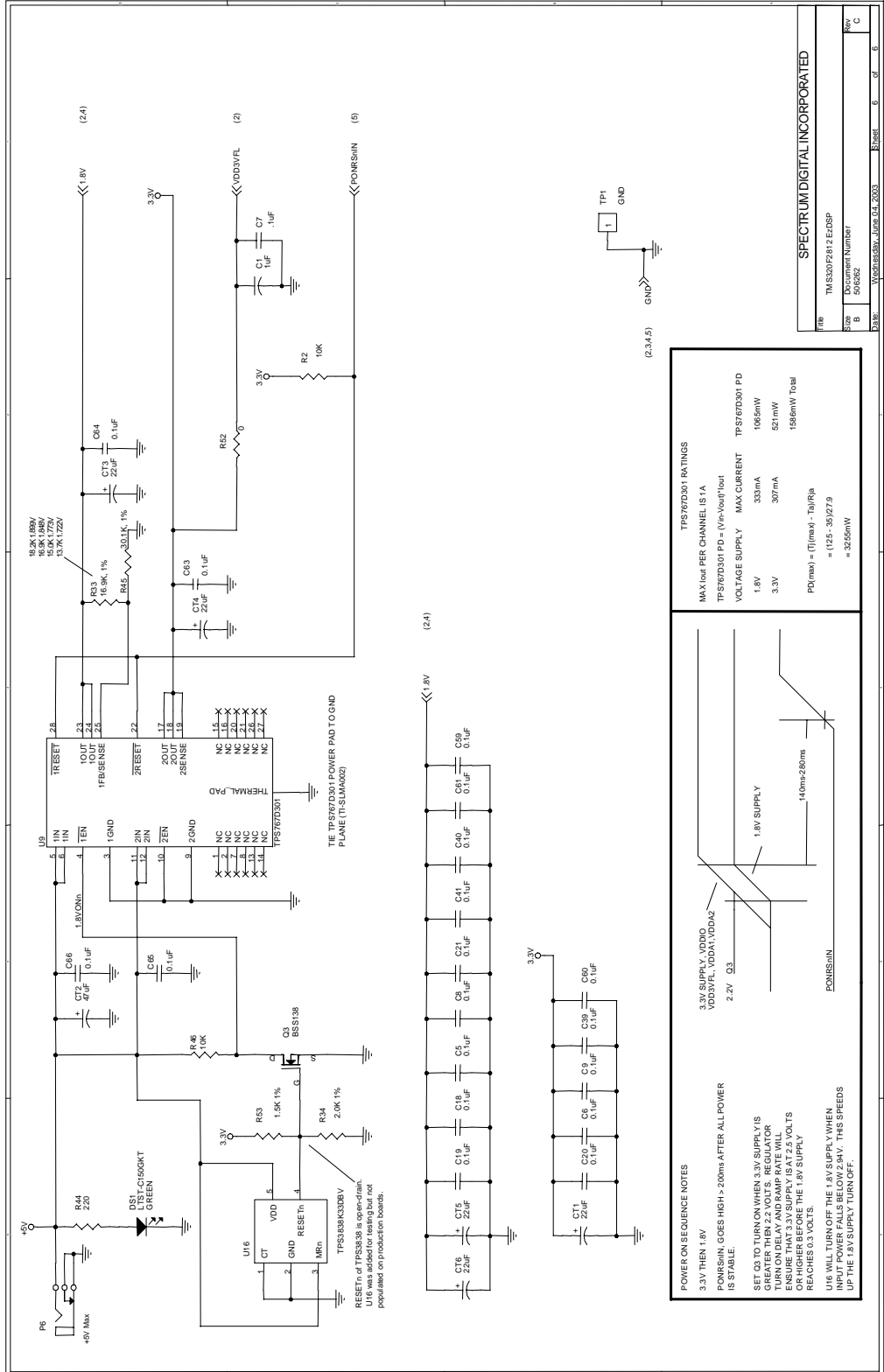





# Appendix B

## eZdsp™ F2812

### Mechanical Information

---

---

---

This appendix contains the mechanical information about the socketed and unsocketed versions of the eZdsp™ F2812

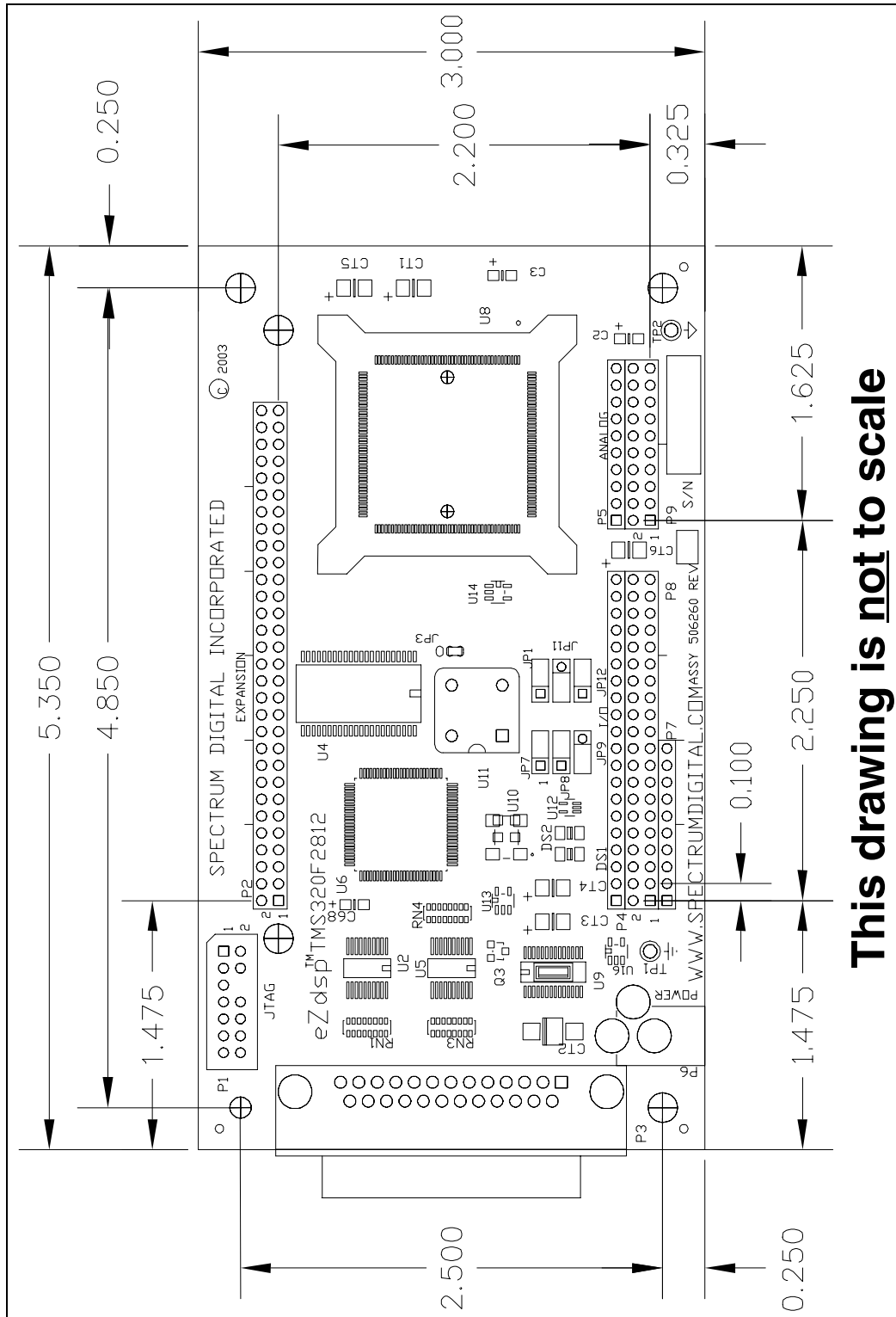







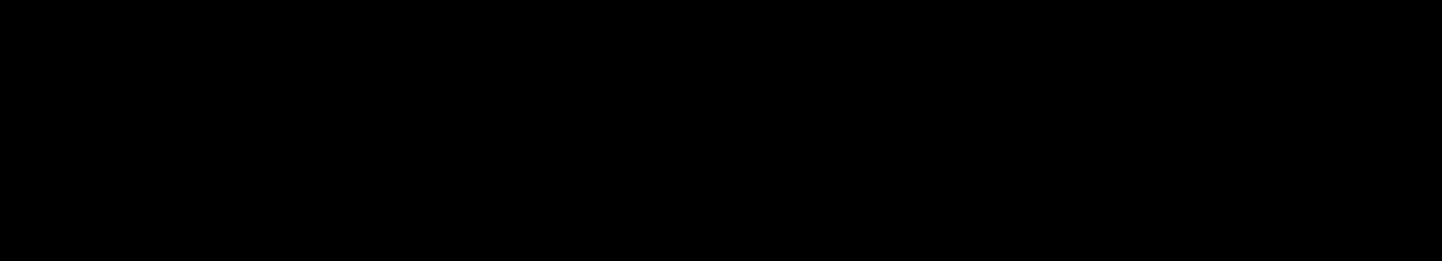

---

Printed in U.S.A., September 2003  
506265-0001 Rev. F